

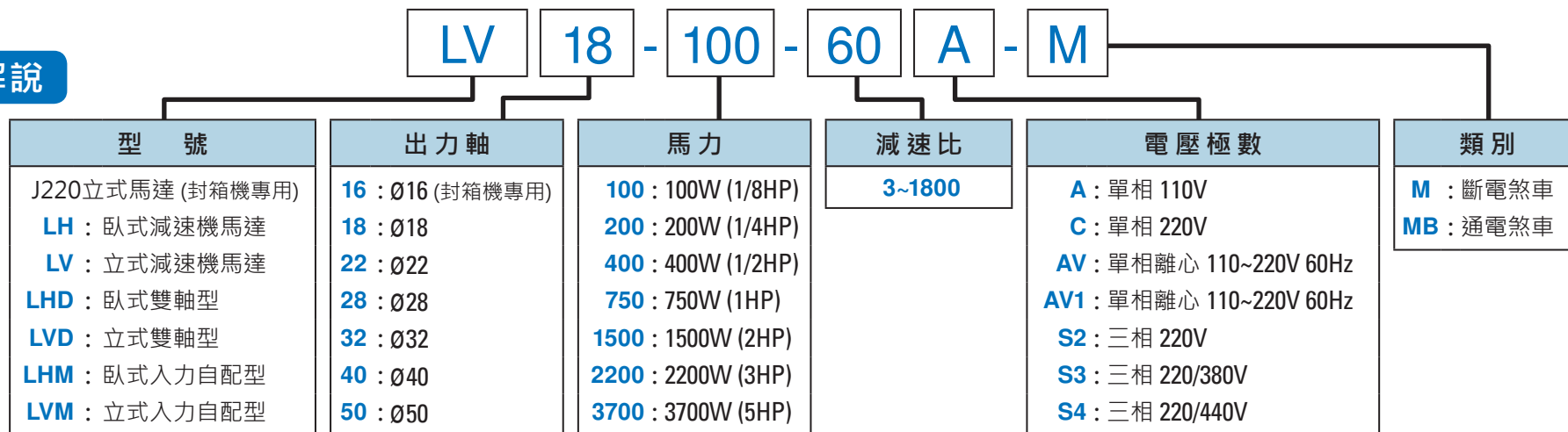

L系列型號解說



安裝方向代號

LH型 (臥式)

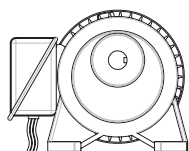

標準型

G1-左方向

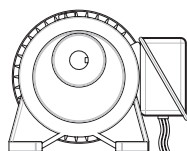

G2-右方向

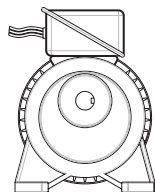

G3-上方向

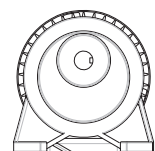

G4-下方向

LV型 (立式)

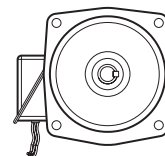

標準型

G1-左方向

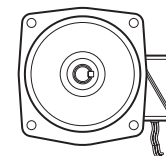

G2-右方向

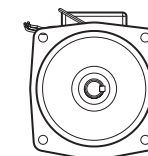

G3-上方向

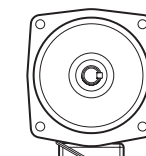

G4-下方向

入線口方向

L

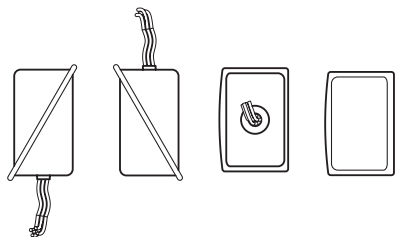

LD

LT

LF

LB

R

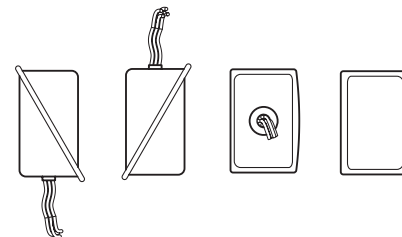

RD

RT

RF

RB

T

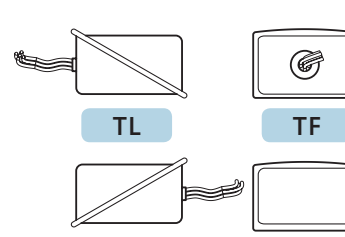

TL

TF

TR

TB

D

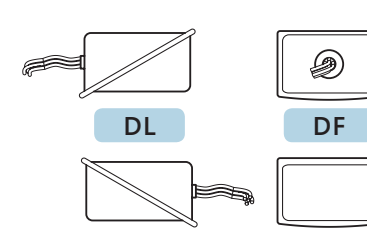

DL

DF

DR

DB



MODEL 臥式齒輪馬達

LH

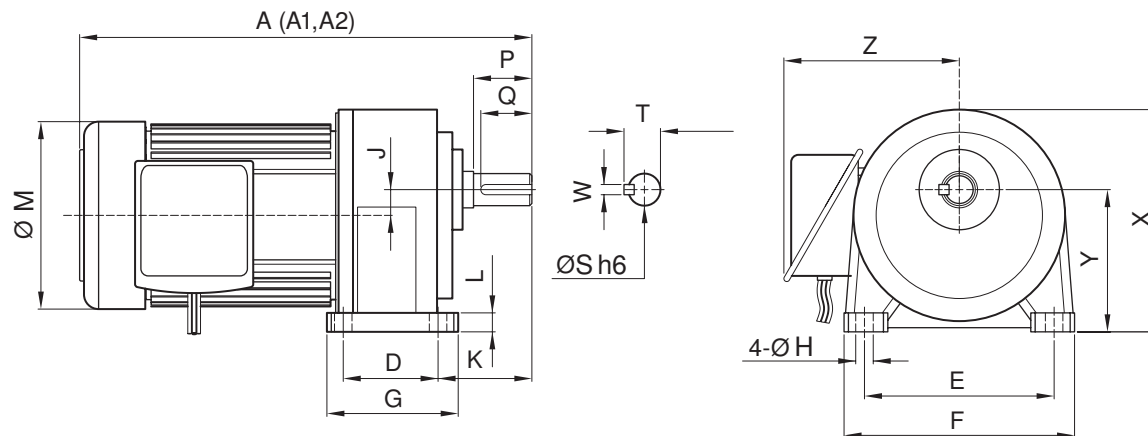

尺寸表 DIMENSION (mm)

框號	本體	馬力	減速比	A	A1	A2	D	E	F	G	H	J	K	L	M	X	Y	Z	出力軸端				
																			S	P	W	T	Q
18	1	100W	3~50 (60~200)	265	280	265	40	110	135	65	9	16	45	10	130	131	88.5	120	18	29	5	20	25
22	2	(1/8 HP)	60~200	275	280	305	65	130	158	90	11	17.65	63	13	130	153	97.5	120	22	40	7	25	35
18	1	200W (1/4 HP)	3~10 (12.5~90)	285	300	285	40	110	135	65	9	16	45	10	130	131	88.5	120	18	29	5	20	25
22	2		12.5~90 (100~200)	310	315	340	65	130	158	90	11	17.65	63	13	130	153	97.5	120	22	40	7	25	35
28	3		100~200	330	335	360	90	140	180	120	11	24.22	68.5	16	130	174	116	120	28	45	7	31	40
22	2	400W (1/2 HP)	3~10 (12.5~90)	330	335	360	65	130	158	90	11	17.65	63	13	162	153	97.5	135	22	40	7	25	35
28	3		12.5~90 (100~200)	360	365	390	90	140	180	120	11	24.22	68.5	16	162	174	116	135	28	45	7	31	40
32	4		100~200	395	395	425	130	170	210	165	13	30.22	70	20	162	198	130	135	32	55	10	35.5	50
22	2	750W (1 HP)	(3~25)	340	345	370	65	130	158	90	11	17.65	63	13	162	153	97.5	135	22	40	7	25	35
28	3		3~25 (30~120)	370	375	400	90	140	180	120	11	24.22	68.5	16	162	174	116	135	28	45	7	31	40
32	4		30~120 (125~200)	410	410	445	130	170	210	165	13	30.22	70	20	162	198	130	135	32	55	10	35.5	50
40	5		125~200	465	465	500	150	210	265	198	13	36	89	24	162	250	162	135	40	65	10	43.5	60
32	4	1.5 kW (2 HP)	3~30 (40~100)	450	450	450	130	170	210	165	13	30.22	70	20	192	198	130	146	32	55	10	35.5	50
40	5		40~100 (110~150)	510	510	510	150	210	265	198	15	36	89	24	192	250	162	146	40	65	10	43.5	60
50	6		110~180	560	560	560	170	265	319	238	18	51	120	31.5	192	308	200	146	50	80	14	54	75
40	5	2.2 kW (3 HP)	3~40 (45~80)	530	530	-	150	210	265	198	15	36	89	24	220	250	162	160	40	65	10	43.5	60
50	6		45~100	580	580	-	170	265	319	238	18	51	120	31.5	220	308	200	160	50	80	14	54	75
40	5	3.7 kW (5 HP)	3~10 (15~60)	560	560	-	150	210	265	198	15	36	89	24	220	250	162	160	40	65	10	43.5	60
50	6		15~60	620	620	-	170	265	319	238	18	51	120	31.5	220	308	200	160	50	80	14	54	75

⚠ () 表示輕荷重 / 縮框機型

備註：(一) A: 三相鋁殼馬達 A1: 三相馬達附剎車器 A2: 單相鋁殼馬達
(二) 單相馬達附剎車器尺寸另定。



MODEL 立式齒輪馬達

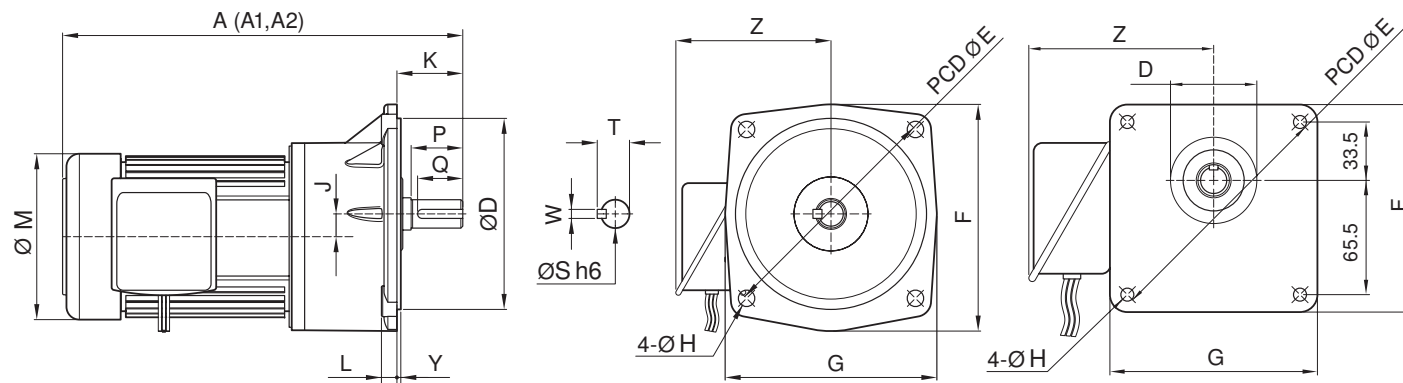

尺寸表 DIMENSION (mm)

框號	本體	馬力	減速比	A	A1	A2	D	E	F	G	H	J	K	L	M	Y	Z	出力軸端				
																		S	P	W	T	Q
18	1	100W	3~50 (60~200)	265	280	265	50	140	119	119	9	16	40	12	130	-	120	18	29	5	20	25
22	2	(1/8 HP)	60~200	275	280	305	148	185	176	164	11	17.65	50	12	130	3	120	22	40	7	25	35
18	1	200W (1/4 HP)	3~10 (12.5~90)	285	300	285	50	140	119	119	9	16	40	12	130	-	120	18	29	5	20	25
22	2		12.5~90 (100~200)	310	315	340	148	185	176	164	11	17.65	50	12	130	3	120	22	40	7	25	35
28	3		100~200	330	335	360	170	220	216	216	11	24.22	60	15	130	6	120	28	45	7	31	40
22	2	400W (1/2 HP)	3~10 (12.5~90)	330	335	360	148	185	176	164	11	17.65	50	12	162	3	135	22	40	7	25	35
28	3		12.5~90 (100~200)	360	365	390	170	220	216	216	11	24.22	60	15	162	6	135	28	45	7	31	40
32	4		100~200	395	395	425	185	255	241	225	13	30.22	65	15	162	4	135	32	55	10	35.5	50
22	2	750W (1 HP)	(3~25)	340	345	370	148	185	176	164	11	17.65	50	12	162	3	135	22	40	7	25	35
28	3		3~25 (30~120)	370	375	400	170	220	216	216	11	24.22	60	15	162	6	135	28	45	7	31	40
32	4		30~120 (125~200)	410	410	445	185	255	241	225	13	30.22	65	15	162	4	135	32	55	10	35.5	50
40	5		125~200	465	465	500	230	310	291	272	13	36	85	21	162	5	135	40	65	10	43.5	60
32	4	1.5 kW (2 HP)	3~30 (40~100)	450	450	450	185	255	241	225	13	30.22	65	15	192	4	146	32	55	10	35.5	50
40	5		40~100 (110~150)	510	510	510	230	310	291	272	15	36	85	21	192	5	146	40	65	10	43.5	60
50	6		110~180	560	560	560	280	390	369	341	18	51	92	25	192	5	146	50	80	14	54	75
40	5	2.2 kW (3 HP)	3~40 (45~80)	530	530	-	230	310	291	272	15	36	85	21	220	5	160	40	65	10	43.5	60
50	6		45~100	580	580	-	280	390	369	341	18	51	92	25	220	5	160	50	80	14	54	75
40	5	3.7 kW (5 HP)	3~10 (15~60)	560	560	-	230	310	291	272	15	36	85	21	220	5	160	40	65	10	43.5	60
50	6		15~60	620	620	-	280	390	369	341	18	51	92	25	220	5	160	50	80	14	54	75

⚠ () 表示輕荷重 / 縮框機型

備註：(一) A: 三相鋁殼馬達 A1: 三相馬達附剎車器 A2: 單相鋁殼馬達
(二) 單相馬達附剎車器尺寸另定。